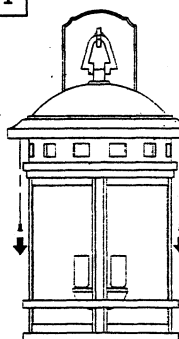
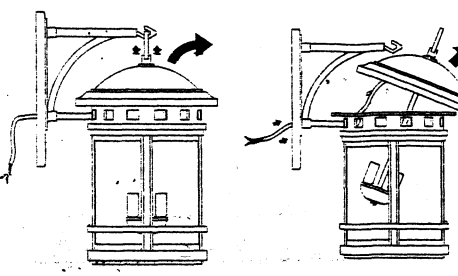
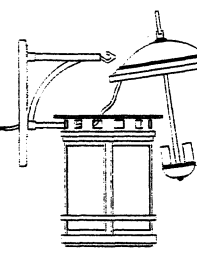
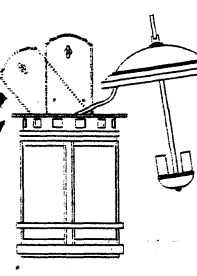
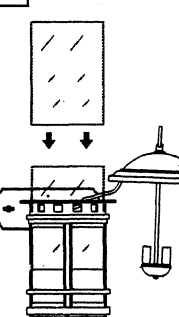
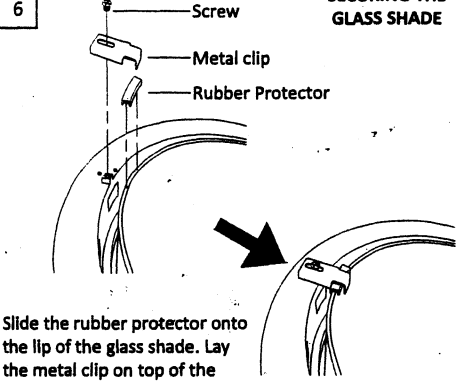
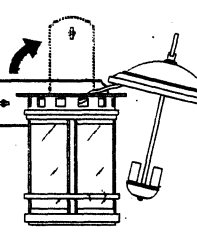
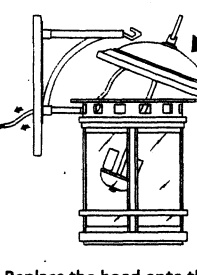
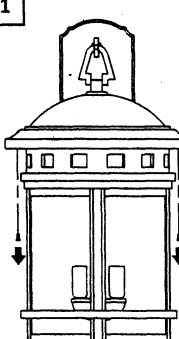
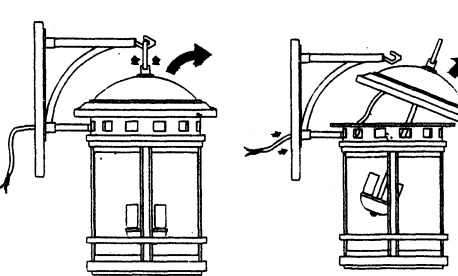
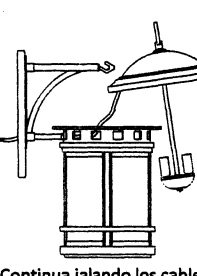
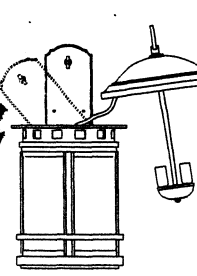
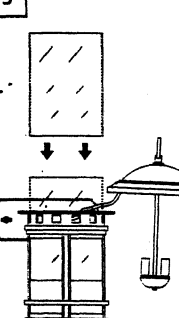
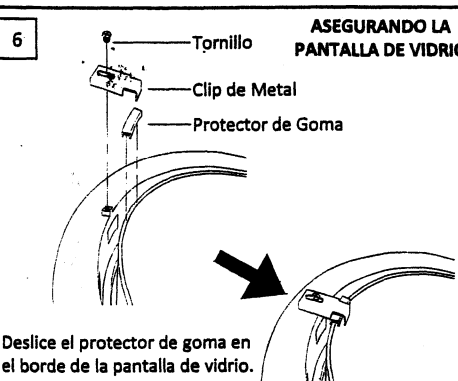
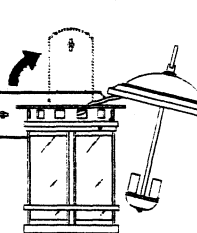
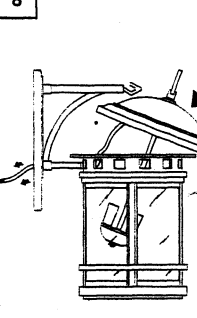

**DESIGNERS FOUNTAIN SEDONA MODEL N<sup>OS</sup> 2370, 2371, ES2370, ES2371 - GLASS SHADE INSTALLATION**

<p>1</p>  <p>Remove hood/cage screws.</p>	<p>2</p>  <p>Lift off hood from cage. Carefully pull wiring through-arm for needed slack.</p>	<p>3</p>  <p>Continue pulling the wires until there is enough slack to lift socket cluster completely out of cage.</p>	<p>4</p>  <p>Rotate wall plate 90°.</p>
<p>5</p>  <p>Slide glass shade into cage.</p>	<p>6</p> <p><b>SECURING THE GLASS SHADE</b></p>  <p>Slide the rubber protector onto the lip of the glass shade. Lay the metal clip on top of the rubber protector, aligning its hole with the mounting hole on the cage. Thread the screw into the mounting hole to secure the metal clip. Repeat for the remaining three parts sets.</p>	<p>7</p>  <p>Rotate wall plate back to original position.</p>	<p>8</p>  <p>Replace the hood onto the cage, pulling the wiring back through the backside of the wall plate. Secure the hood using the hood/cage screws.</p>

**DESIGNERS FOUNTAIN SEDONA MODELOS N<sup>º</sup> 2370, 2371, ES2370, ES2371 - INSTALACIÓN DE PANTALLA DE VIDRIO**

<p>1</p>  <p>Retire los tornillos de jaula/capó.</p>	<p>2</p>  <p>Levante capó de la jaula. Con cuidado saque el cableado a través del brazo de la jaula de la holgura necesaria.</p>	<p>3</p>  <p>Continúa jalando los cables hasta que haya suficiente holgura para levantar el grupo de zócalo completamente fuera de la jaula.</p>	<p>4</p>  <p>Gire la placa de pared 90°.</p>
<p>5</p>  <p>Slide glass shade into cage.</p>	<p>6</p> <p><b>ASEGURANDO LA PANTALLA DE VIDRIO</b></p>  <p>Deslice el protector de goma en el borde de la pantalla de vidrio. Coloque el clip de metal sobre el protector de goma, alinea su agujero con el agujero de montaje en la jaula. Pase el</p>	<p>7</p>  <p>Gire la placa de pared a su</p>	<p>8</p>  <p>Reemplace el capó en la jaula, jalando el cableado a través de la parte trasera de la placa de pared.</p>

## INSTALLATION INSTRUCTIONS

PLEASE READ CAREFULLY AND SAVE THESE INSTRUCTIONS, AS YOU MAY NEED THEM AT A LATER DATE.

**CAUTION** - Turn off the main power at the circuit breaker before installing the fixture, in order to prevent possible shock.

Remove the fixture and the mounting package from the box and make sure that no parts are missing by referencing the illustrations on the installation instructions.

### FOR WALL MOUNT ( Fig. 1 & 2 )

1. A) Place the #8-32 HEX NUT(5) onto the #8-32 FIXTURE MOUNTING SCREW(7). And attach the FIXTURE MOUNTING SCREW (7) to the MOUNTING RACKET(4) or universal mounting plate (whichever is provided). Do not tighten the HEX NUTS at this time.(Fig.1)  
 B) If the fixture uses a single 1/8" IPS NIPPLE(7) for mounting, thread the 1/8" IPS HEX NUT(5) onto the NIPPLE (7), and screw the NIPPLE(7) into the MOUNTING BRACKET(4) without tightening the HEX NUT(5).(Fig.2)
2. Pull the power supply wires out from the OUTLET BOX (3) and mount the MOUNTING BRACKET (4) or the universal mounting plate to the OUTLET BOX(3), using MOUNTING SCREWS(6).
3. Attach the SUPPLY BLACK WIRE (10) to the BLACK FIXTURE LEAD WIRE (11) by using the WIRE CONNECTOR (12). In the same manner, attach the SUPPLY WHITE WIRE (8) to the WHITE FIXTURE LEAD WIRE (9). Connect the POWER SUPPLY GROUND WIRE (13) to the FIXTURE GROUND WIRE (14) using a WIRE CONNECTOR (12) (not included).
4. Place the CANOPY(15) on the fixture over the OUTLET BOX(3) and onto the fixture mounting screws or NIPPLE (7). and adjust the #8-32 fixture mounting screws (or NIPPLE) until they protrude out from the CANOPY(15) 1/4". Remove the CANOPY(15) and secure the position of the fixture mounting screw (or NIPPLE) by tightening the HEX NUT(S)(5) against the MOUNTING RACKET(4). Place the CANOPY(15) back onto the fixture mounting screws.(or NIPPLE), and secure into place using the DECORATIVE NUT(16) provided.
5. Screw the TAIL SECTION (18) (if provided) onto the COUPLING (19) located at the bottom of the lamp compartment.
6. Screw a light bulb that does not exceed the maximum wattage specified on the fixture label, into socket located inside the lamp compartment. Place the lamp cover onto the top of the lamp compartment, and secure in position using the decorative head screws provided.

### INSTALLATION COMPLETED

#### FOR POST MOUNT(Fig.3)

1. Place the fixture on the top of the POST (9) on which the fixture is to be mounted and position as desired. Using the holes located on the POST CAP (3) mark the hole position on the POST (9). Remove the fixture from the POST (9) and drill a 1/8" diameter hole at each marked position on the POST (9).
2. Pull the power supply wires out from the POST (9) and the fixture lead wires out from the POST CAP (3), and attach the wires together by connecting BLACK to BLACK (6) and WHITE to WHITE (5). Attach the POWER SUPPLY GROUND WIRE (7) to the FIXTURE GROUND WIRE (8) using a wire connector rated for the size of wire being connected.
3. Place the connected wires down inside the POST (9), and mount the POST CAP (3) in place, aligning the holes in the POST CAP (3) with the ones on the POST (9). Secure the POST CAP (3) to the POST (9) using #10x1/2" long self-tapping SHEET METAL SCREWS (4) provided.
4. Screw a light bulb that does not exceed the maximum wattage specified on the fixture label, into the lamp socket. Place the LAMP COVER (1) onto the top of the lamp compartment, and secure in position using the DECORATIVE HEAD SCREWS (2) provided.

### INSTALLATION COMPLETED

- 1.TOP COVER
- 2.DECORATIVE SCREWS
- 3.OUTLET BOX
- 4.MOUNTING BRACKET
- 5.#8-32 IPS HEX NUT
- 6.MOUNTING SCREWS
- 7.FIXTURE MOUNTING SCREW
- 8.SUPPLY WHITE WIRE
- 9.WHITE FIXTURE LEAD WIRE
- 10.SUPPLY BLACK WIRE
11. BLACK FIXTURE LEAD WIRE
12. WIRE CONNECTOR
- 13.POWER SUPPLY GROUND WIRE
- 14.FIXTURE GROUND WIRE
- 15.CANOPY
- 16.DECORATIVE NUT
- 17.TAIL PIPE
- 18.TAIL SECTION

Fig.1

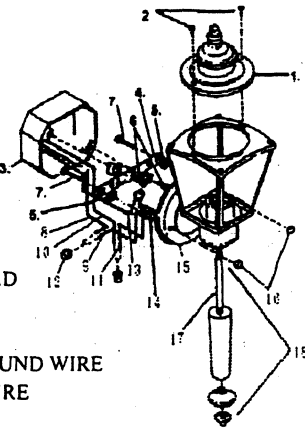

- 1.TOP COVER
- 2.DECORATIVE SCREWS
- 3.OUTLET BOX
- 4.MOUNTING BRACKET
- 5.1/8" IPS HEX NUT
- 6.MOUNTING SCREWS
7. NIPPLE
- 8.SUPPLY WHITE WIRE
- 9.WHITE FIXTURE LEAD WIRE
- 10.SUPPLY BLACK WIRE
11. BLACK FIXTURE LEAD WIRE
12. WIRE CONNECTOR
- 13.POWER SUPPLY GROUND WIRE
- 14.FIXTURE GROUND WIRE
- 15.CANOPY
- 16.DECORATIVE NUT
- 17.TAIL PIPE
- 18.TAIL SECTION
- 19.COUPLING

Fig.2

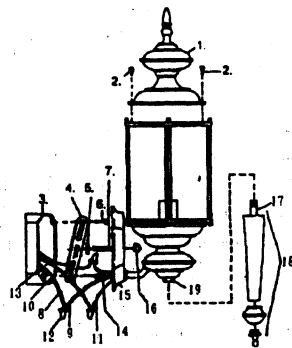

1. LAMP COVER
2. DECORATIVE HEAD SCREW
3. POST CAP
4. SHEET METAL SCREW
5. WHITE TO WHITE WIRE CONNECTION
6. BLACK TO BLACK WIRE CONNECTION
7. POWER SUPPLY GROUND WIRE
8. FIXTURE GROUND WIRE
9. POST

Fig.3

